

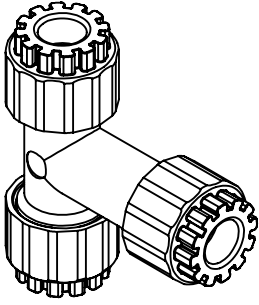

# LARGE BORE FITTINGS

ALB/407



ALB/408

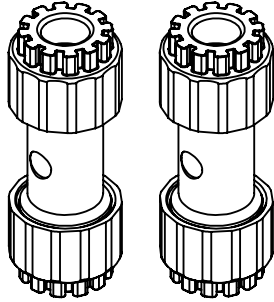

ALB/434

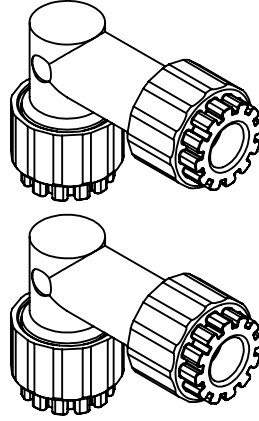

ALB/437

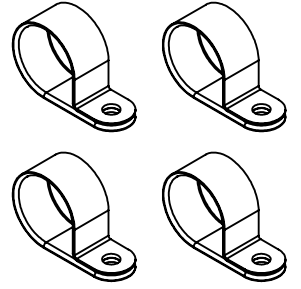

60psi (4.14bar) maximum operating pressure  
To be used with Ambic supplied tubing only  
Visit [www.ambic.co.uk](http://www.ambic.co.uk) for a full list of spares

LB7500 (23/05/2017)

LLDPE Tube  
1/2"(12.7mm) OD, 3/8"(9.525mm) ID  
ALB/410 (6m)  
ALB/428 (30m)

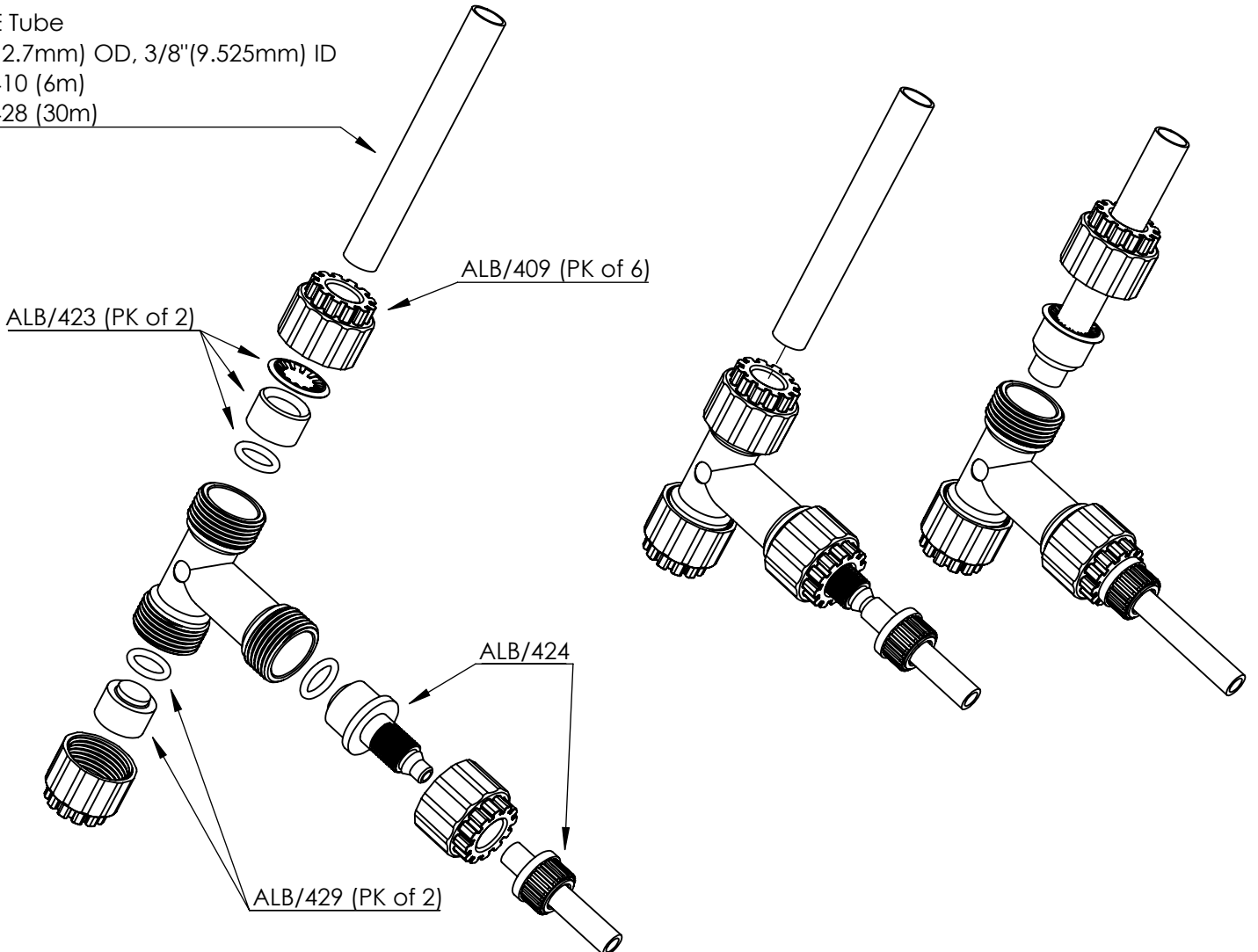



# LARGE BORE FITTINGS

ALB/407

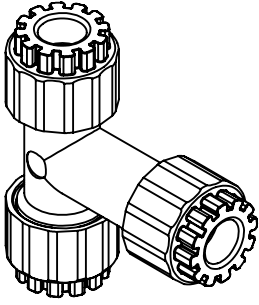

ALB/408

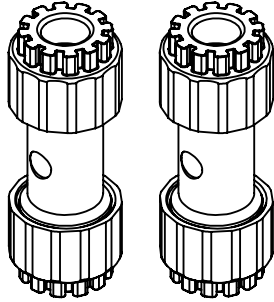

ALB/434

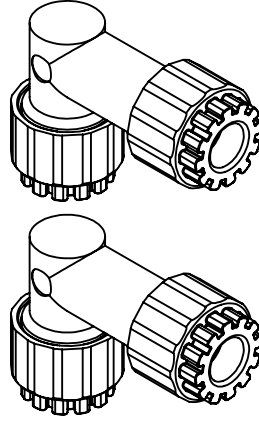

ALB/437

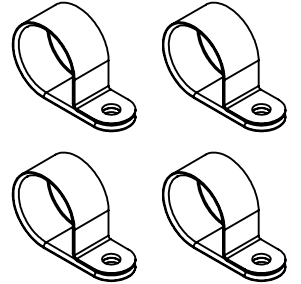

60psi (4.14bar) maximum operating pressure  
 To be used with Ambic supplied tubing only  
 Visit [www.ambic.co.uk](http://www.ambic.co.uk) for a full list of spares

LB7500 (23/05/2017)

LLDPE Tube  
 1/2"(12.7mm) OD, 3/8"(9.525mm) ID  
 ALB/410 (6m)  
 ALB/428 (30m)

